

VELVET Mini 2 IP54

Ref.: VM2IP54

Datasheet: June 2021 / Page 1



Bicolor weatherproof compact panoramic soft light LED panels

[Click here for more product information](#)

VM2IP54 includes: DC in XLR-3, DMX in XLR-5,
1x yoke with 28mm junior pin - 16mm baby receiver



1. Power switch
2. XLR-3 DC In connector
3. Docking plate
4. +/- adjustment buttons
5. 3200K / 5600K Quick access button
6. Mode selection button (Dimmer / Colour Temperature)
7. Digital display
8. XLR-5 DMX RDM In & Out connector



VELVET Mini 2 IP54

Ref.: VM2IP54

Datasheet: June 2021 / Page 2



COLOUR TEMPERATURE	adjustable from 2700K to 6500K in 100K increments
LIGHT INTENSITY	dimnable 0 to 100 (smooth and flicker-free)
TLCI	93 at 3200K and 96 at 5600K
DIMENSIONS	607 x 190 x 65 mm / 24" x 7,5" x 2,5" (panel)
WEIGHT	3 kgs / 6,5 lbs (panel)
POWER DRAW	100W / 0,90 Amps at 110 VAC
POWER SUPPLY	12 – 35 VDC through XLR-3 connector Vlock or Gold battery quick link mount 90-264 VAC 50/60Hz through Smart AC adapter
PHOTOMETRICS	2.300 Lux / 213 fc at 1m / 3 feet 300 Lux / 28 fc at 3m / 10 feet
BEAM ANGLE	100°
LED RATED LIFE	more than 50.000 hours
COOLING	no-noise, fan-free passive cooling
PROTECTION	IP54 weatherproof, indoor or outdoor use
CONSTRUCTION & FINISH	made of black anodized extruded aluminum and black powder coated sheet aluminum
VELVET LED TECHNOLOGY	Selected BIN LED + optic diffuser + CPU software control
ACCESSORIES	Smart AC power supply (Vlock or Gold available), VELVET DMX remote control, foldable Snapgrid, foldable SnapBag softbox, removable barn doors, cordura case, hard case
RIGGING OPTIONS	aluminum yoke with 16mm baby receptacle combined with 28mm junior pin, four sliding threads 1/4" for riggings located on panel sides, double baby pin for diagonal or vertical position using the standard yoke

WIRE VIEW

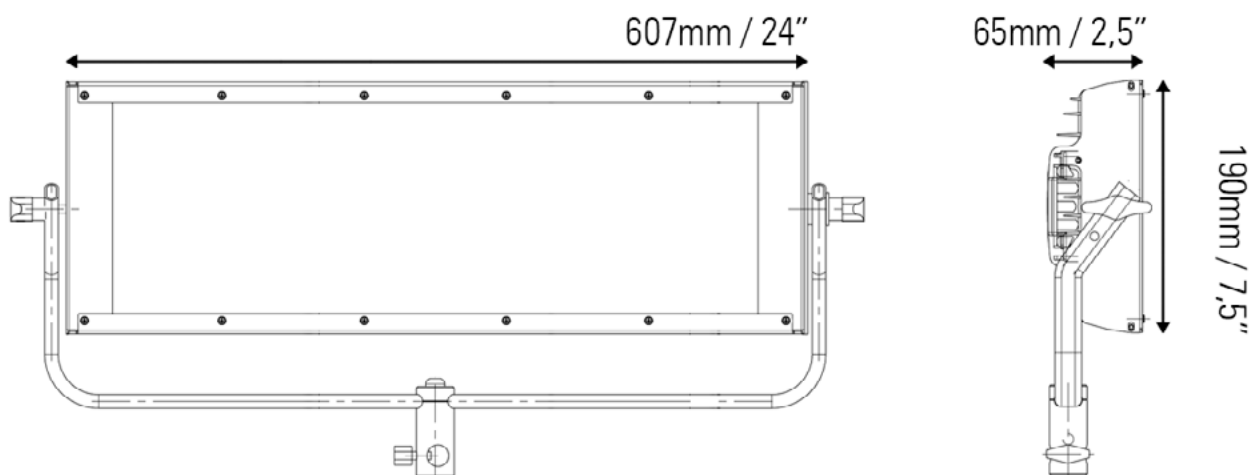

VELVET Mini 2 IP54

Ref.: VM2IP54

Datasheet: June 2021 / Page 3



PHOTOMETRICS

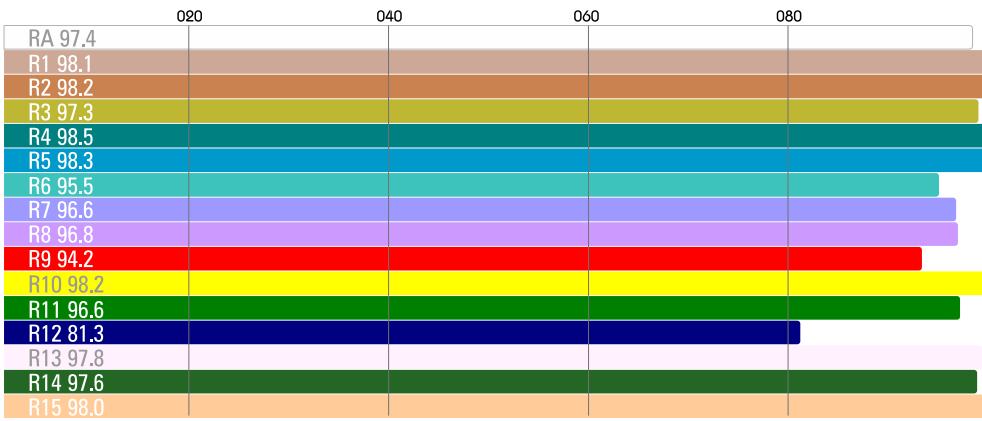
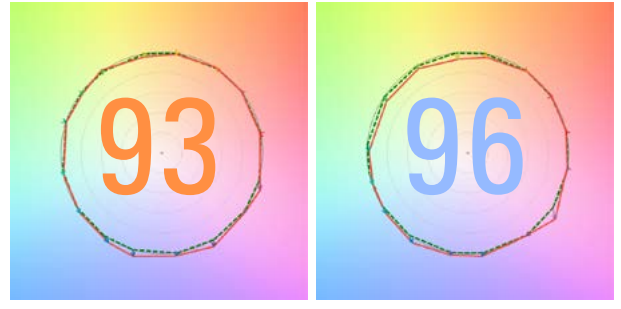
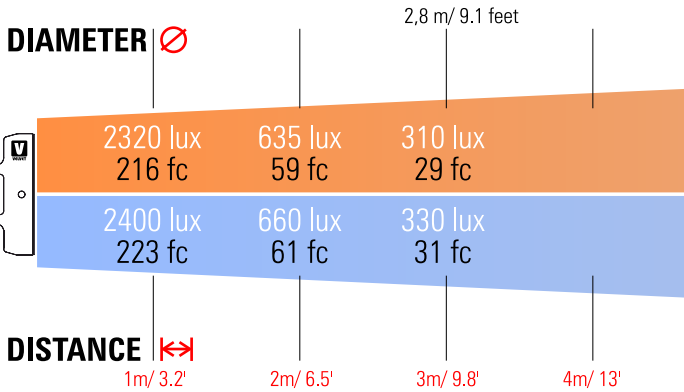

CCT 3231K

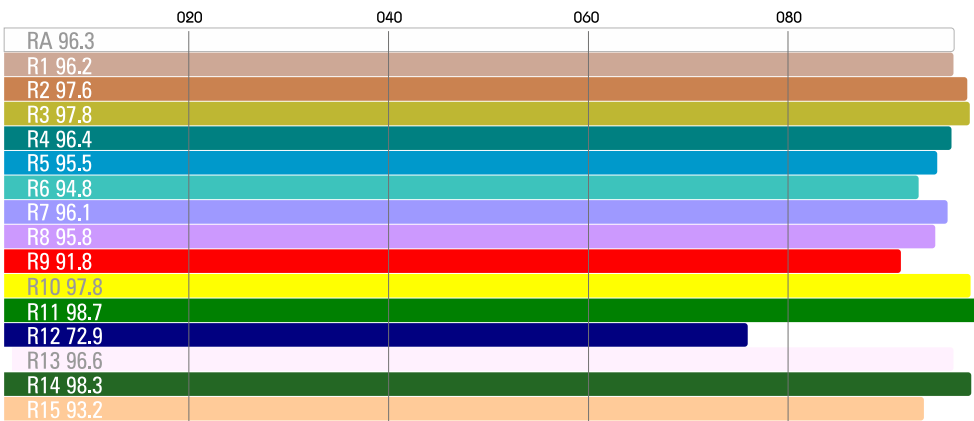

CCT 5638K







VELVET Mini 2 IP54

Ref.: VM2IP54

Datasheet: June 2021 / Page 4



ACCESSORIES

POWER SUPPLY		TRANSPORT	RIGGING
			
VM-PSU200WVL	VM-PSU200WGL	VM2-BAG	VM-QLS
BEAM CONTROL			
			
VM2-RB	VM2-SG	VM2-SB	VM2-SGXSB
BATTERY ADAPTERS		REMOTE CONTROL	
			
VM-VLOCKIP54	VM-VLOCKA	VM-GOLDA	VL-RC