

Ref.: VE2CSTNY

Datasheet: September 2024 / Page 1

2x1 feet dustproof AC powered soft light LED panel R+G+B+W+CW with wireless control

EVO 2 Studio is a dustproof IP51, maintenance-free panel, which runs completely silent, with no fans to service. It operates exclusively on AC power and includes In & Out DMX XLR5 connectors for daisy chaining, Ethernet control through RJ-45, and wireless control through Art-Net Wi-Fi. Its low weight, slim 92mm/3.6" profile and industry-leading power efficiency speed up installation.

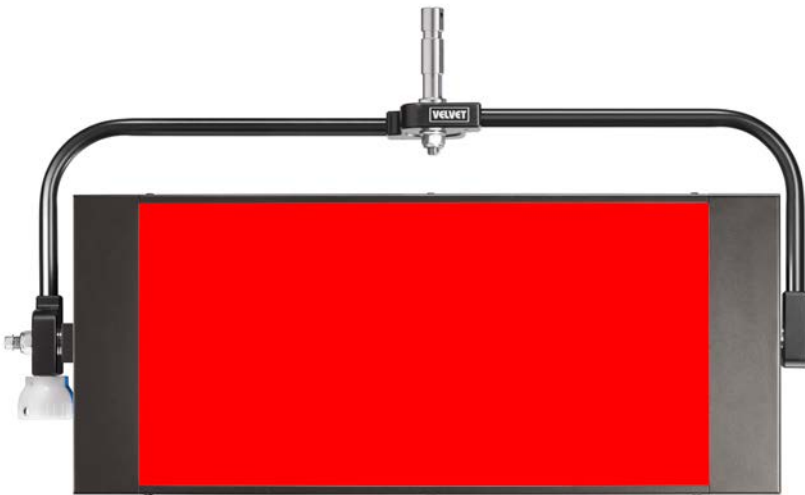

1. XLR-5 DMX RDM In & Out connector
2. Light power button
3. Up and down scroll buttons
4. Enter / +/- Adjustment buttons
5. 3200K / 5600K quick access button
6. Back button
7. Mode selection / Lock button
8. Mini USB connector
9. Main power switch
10. Ethernet RJ-45 LAN connector
11. XLR-3 DC In connector



SPECIFICATIONS	
COLOUR TEMPERATURE	Continuously adjustable from 2500K to 10.000K
GREEN-MAGENTA	Continuously adjustable from full minusgreen to full plusgreen
COLOR SPECTRUM	Full color spectrum R+G+B+W+CW with hue, saturation, and base colortemperature control
CONTROL COLOR MODES	CCT, HSI, RGB, Gels and Effects base Kelvin white light can be set combined with any color
LIGHT INTENSITY	Dimmable 0 to 100, smooth and flicker-free
LOCAL CONTROL	With 8x shock resistant buttons and color display
WIRE CONTROL	DMX-RDM with XLR-5 in & through connectors Ethernet Art-Net with RJ-45 connector
WIRELESS CONTROL	Wi-Fi Art-Net +VELVET Goya App
TLCI INDEX	96 at 3174 and 96 at 5558K
PHOTOMETRICS	1550 lux / 144 fc at 3m / 10 feet 410 lux / 38 fc at 6m / 20 feet
BEAM ANGLE	95°
DIMENSIONS	753 x 318 x 128mm / 29.6 x 12.5 x 5 inches
WEIGHT	8.2 kg / 18 lb. 8.9 kg / 19.6 lb. (panel + yoke)
POWER DRAW	225W (0.85A at 220VAC — 1.8A at 110VAC)
POWER SUPPLY	90-264V AC 50/60Hz
LED RATED LIFE	More than 50.000 hours
POWER CONNECTION	Neutrik PowerCon TRUE1 TOP In connector
OUTPUT FREQUENCY	2000 fps
OPERATION TEMPERATURE	From -20°C to +40°C
COOLING	Silent and fan-free passive cooling
PROTECTION	indoor or outdoor IP51 dustproof protected
VELVET LED CYC TECHNOLOGY	Selected BIN LED core unit + optic diffuser + CPU software control
RIGGING OPTIONS	Aluminum yoke with 16mm baby receptacles combined with 28mm junior pin, multiple ¼"-20 rigging points, double vertical yoke, pole-operated yoke.
QUICK MOUNTING ACCESSORIES	Foldable SnapBag, foldable Snapgrid, removable barn doors, cordura case, hard case
CONSTRUCTION & FINISH	Fixture and yoke made of 100% black powdercoated extruded and sheet aluminum

WIRE VIEW

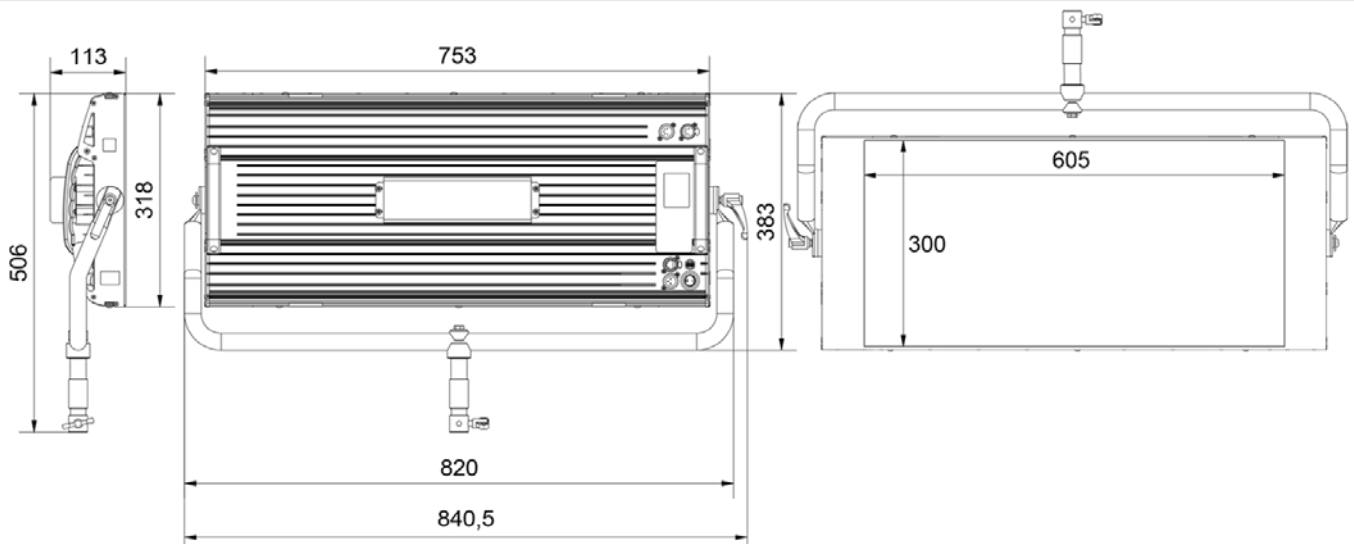

Ref.: VE2CSTNY

Datasheet: September 2024 / Page 3

PHOTOMETRICS

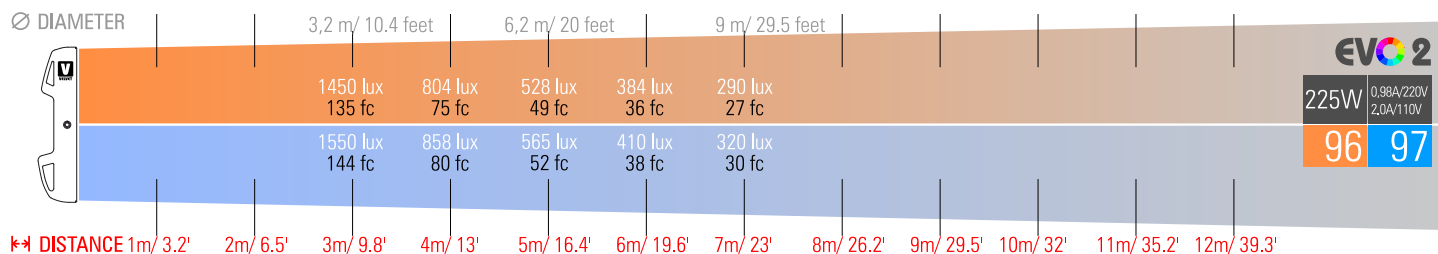
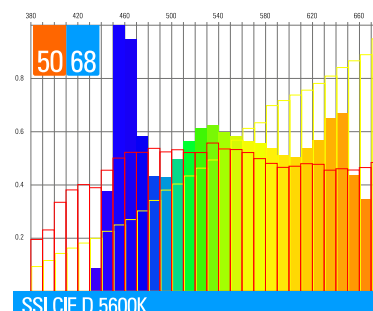
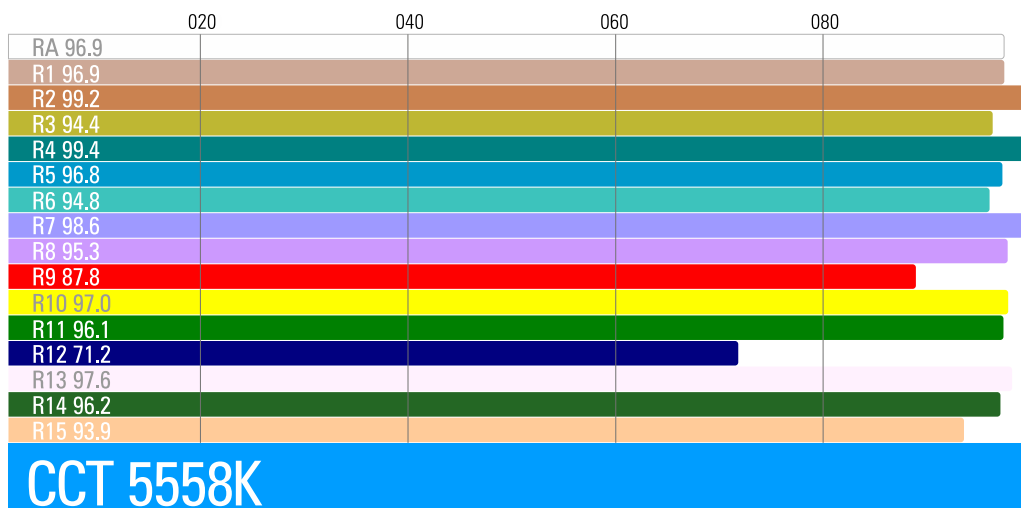
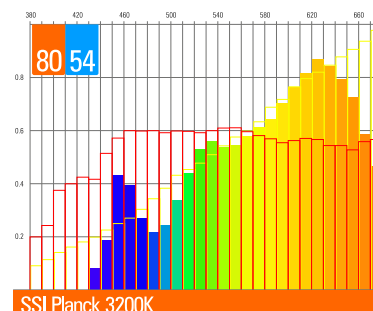
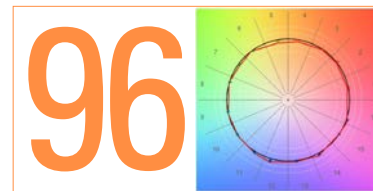
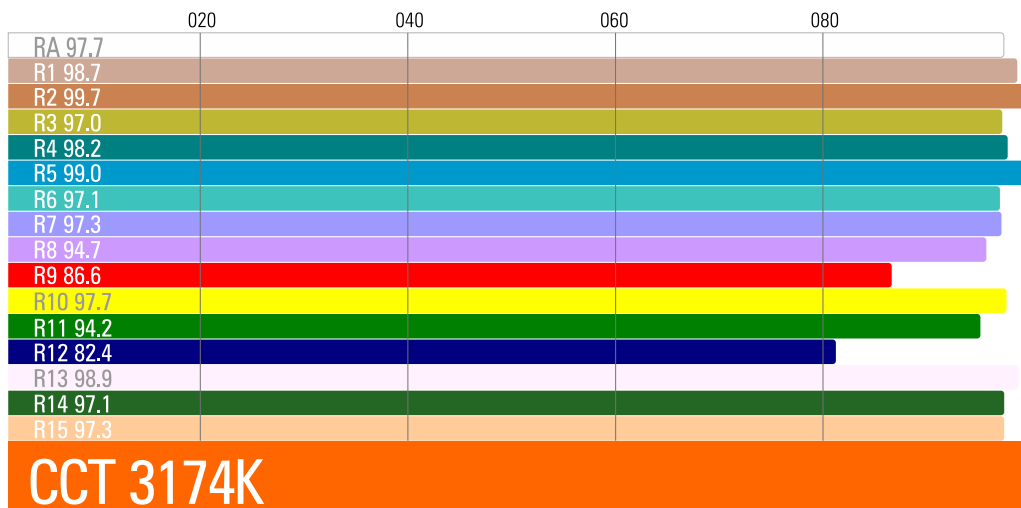

ACCESSORIES

Mandatory accessories

RIGGING

VE2-YT



VE-QLS



VE2-YPO



SPIGOTS AND CLAMPS

EV-2816TK



EV-EURO28TK



V-CCLAMPKIT



POWER CABLES

ACC3.5M-TRUE1



ACC3.5M-TRUE1UK



ACC3.5M-TRUE1A



ACC3.5M-TRUE1BE



Optional accessories

BEAM CONTROL

VE2-RB



VE2-SG



VE2-SB



VE2-SGXSB



VE2-SLOT



2X1-RABBITREC

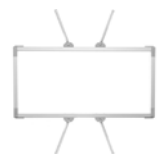

OCTA-SBR05



Ref.: VE2CSTNY

Datasheet: September 2024 / Page 5

OCTA5-SG



TRANSPORT

VE2-BAG



VE2-CASE

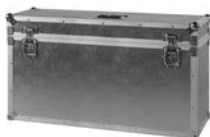

CABLES

CAB-XLR3DCC4.5M



DMX-DMX2M



DMX-DMX3M



DMX-DMX6M



DMX-DMX10M



DMX-DMX20M



REMOTE CONTROL

VE-ROUTER

