

VELVET Light 2x2 Studio IP51



Ref.: VL2X2STNY

Datasheet: October 2023 / Page 1

2x2 feet bicolor dustproof AC powered soft light LED panel

[Click here for more product information](#)

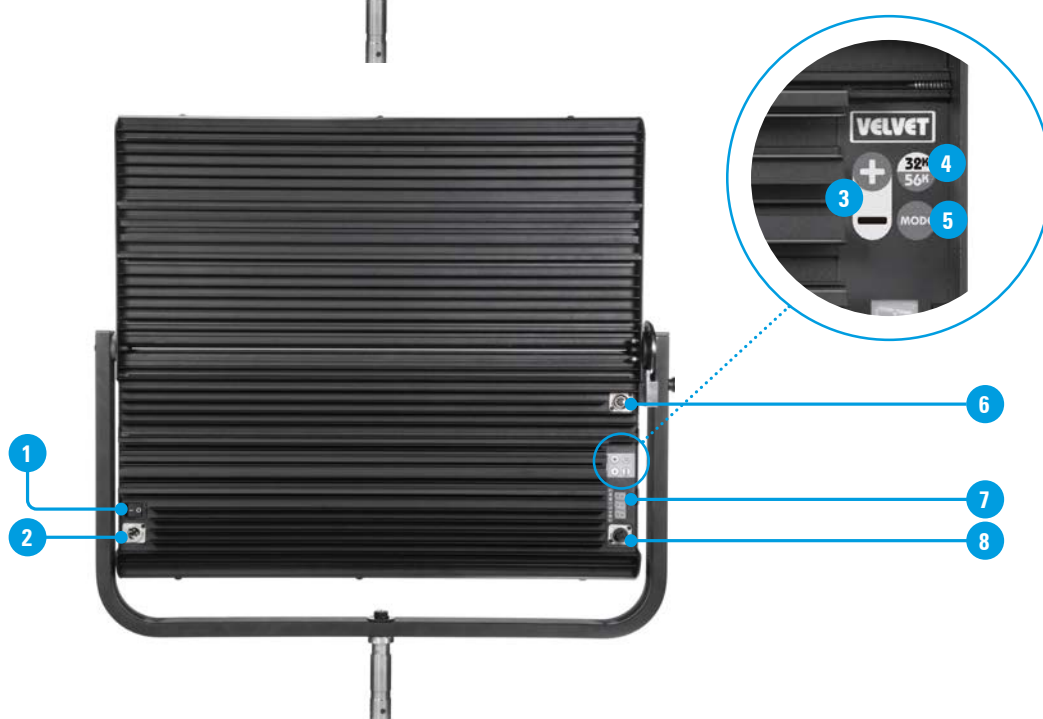

1. Power switch
2. XLR-3 DC IN
3. + / - Adjustment buttons XLR-5 DMX OUT
4. 3200K / 5600K Quick access button
5. Mode selection button (Dimmer / Colour Temp)
6. XLR-5 DMX Out
7. Digital display
8. XLR-5 DMX In

VELVET Light 2x2 Studio IP51



Ref.: VL2X2STNY

Datasheet: October 2023 / Page 2

SPECIFICATIONS

| | |
|----------------------------|---|
| COLOUR TEMPERATURE | Adjustable from 2700K to 6500K (100K increments) |
| LIGHT INTENSITY | Dimmable 0 to 100 (smooth and flicker-free) |
| LOCAL CONTROL | Shock proof buttons and display |
| WIRE CONTROL | DMX-RDM with XLR-5 In & Out connectors |
| TLCI INDEX | 95 at 3270K and 95 at 5740K |
| PHOTOMETRICS | 11570 lux / 1075 fc at 1m / 3 feet 1516 lux / 140.8 fc at 3m / 10 feet 475 lux / 44 fc at 6m / 20 feet |
| BEAM ANGLE | 100° |
| DIMENSIONS | 670x620x68mm / 26"x24,5"x2.7" (panel) 690x750x125mm / 27"x29,5"x5" (panel + yoke) |
| WEIGHT | 12 kg / 26.5 lbs (panel) 14 kg / 30 lbs (panel + yoke) |
| POWER DRAW | 310W (1.35A at 220VAC — 2.80A at 110VAC) |
| POWER SUPPLY | 26-28V DC 90-264V AC 50/60Hz |
| LED RATED LIFE | More than 50.000 hours |
| POWER CONNECTION | Neutrik XLR-3 DC In connector |
| OUTPUT FREQUENCY | 2000 fps |
| OPERATION TEMPERATURE | From -20°C to +40°C |
| COOLING | No-noise, fan-free passive cooling |
| PROTECTION | IP51 dustproof, indoor or outdoor protected use |
| VELVET LED TECHNOLOGY | Selected BIN LED + optic diffuser + CPU software control |
| RIGGING OPTIONS | Aluminum yoke with 28mm junior pin, multiple ¼-20" rigging points, multipanels yokes, pole operated yoke |
| QUICK MOUNTING ACCESSORIES | AC power supply, power extension cable, remote control, foldable Snapgrid 40° or 20°, foldable Snapbag, removable barn doors, hard case |
| CONSTRUCTION & FINISH | Black anodized extruded aluminum and black powder coated sheet aluminum |

VELVET Light 2X2+ MO Yoke

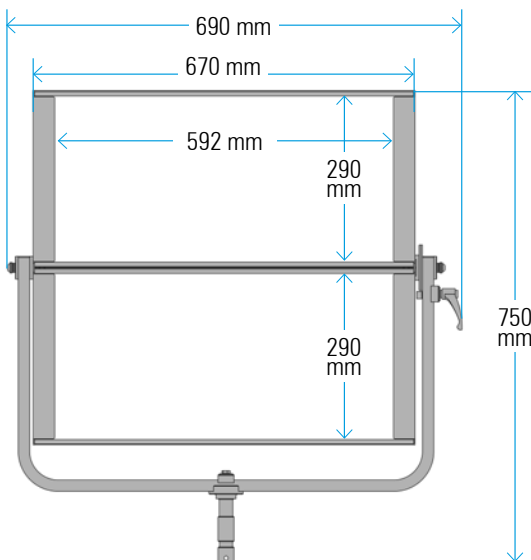

VELVET Light 2X2+ PO Yoke

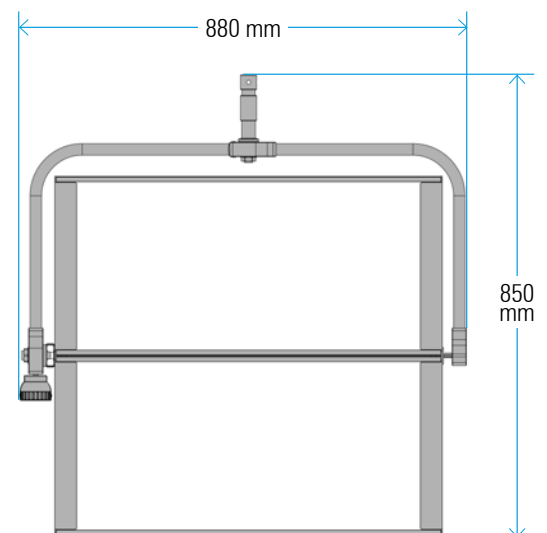

VELVET Light 2x2 Studio IP51



Ref.: VL2X2STNY

Datasheet: October 2023 / Page 3

PHOTOMETRICS

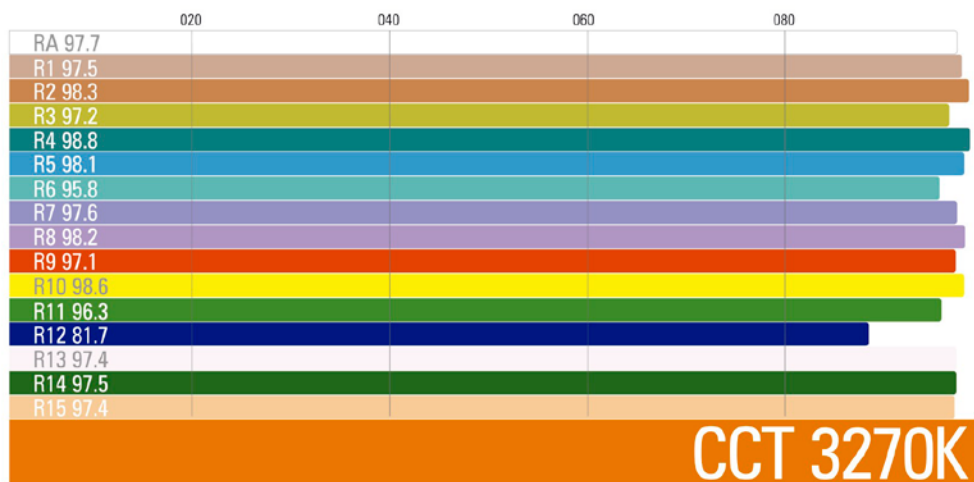

95

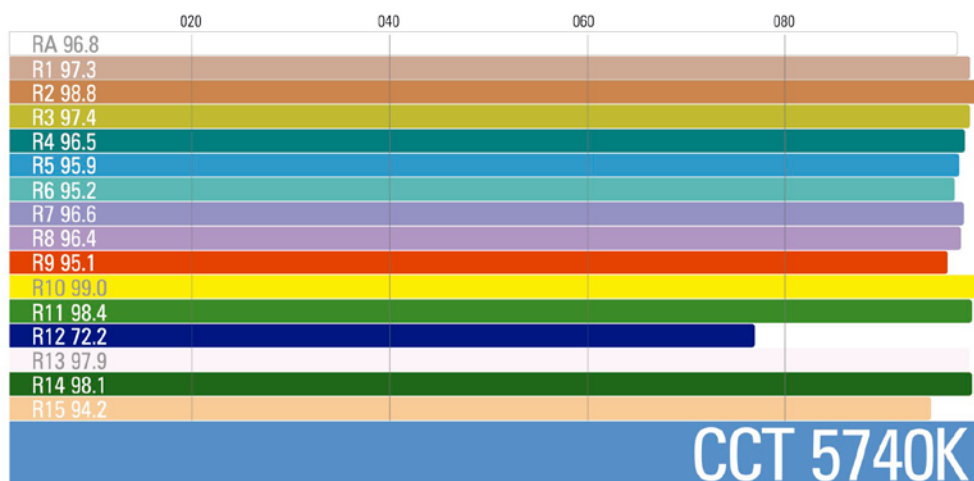
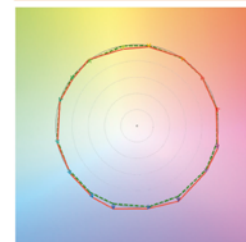

95

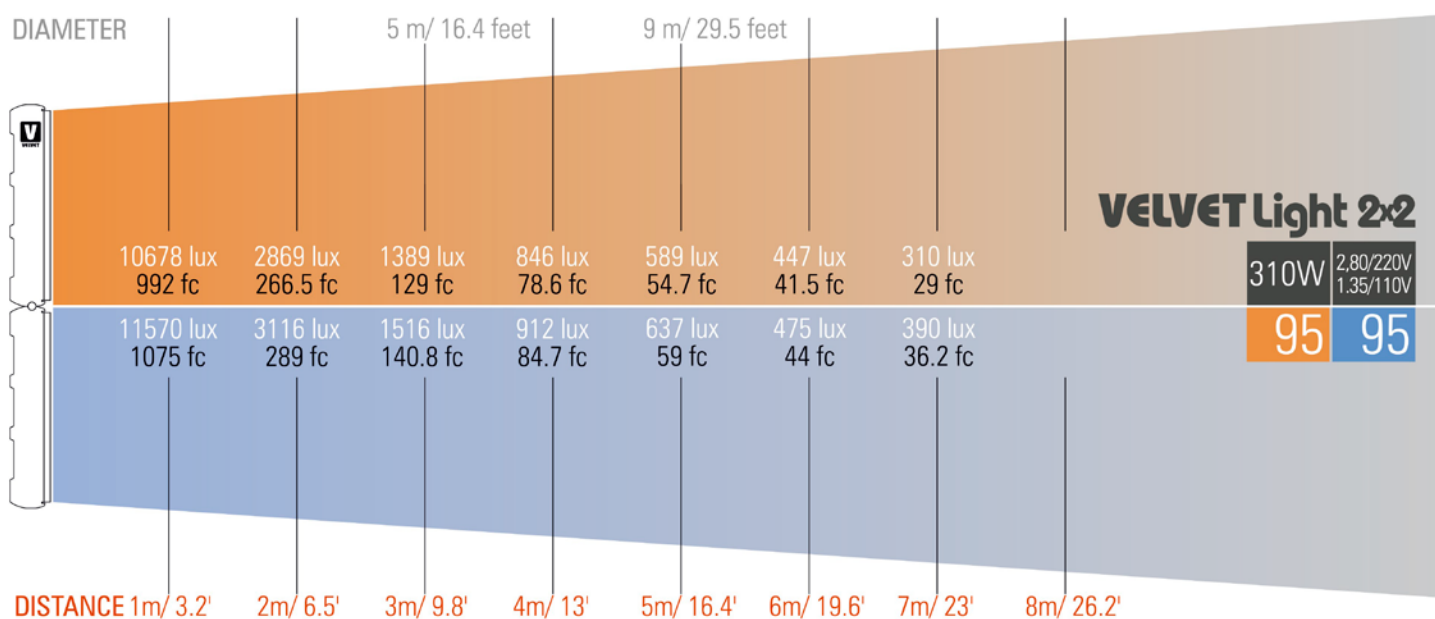
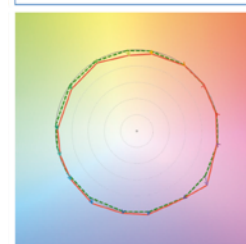

















VELVET Light 2x2 Studio IP51



Ref.: VL2X2STNY

Datasheet: October 2023 / Page 4

ACCESSORIES

| POWER SUPPLY | RIGGING | | TRANSPORT |
|---|--|--|---|
|  VL2x2ST-PSU |  VL2X2-YPO |  VL2X2-YD |  VL2x2-CASE |
| BEAM CONTROL | | | |
|  VL2x2-RB |  VL2x2-SG |  VL2x2-SG20 |  VL2X2-SB |
|  VL2X2-SGXSB |  VL2X2-SPACEKIT |  VL2x2-H |  VL2x2-SLOTKIT |
|  2X2-RABBITSQ |  OCTA-SBR05 |  OCTA-SBR07 | REMOTE CONTROL |
| | | |  VL-RC |