

KOSMOS 400

color tunable fresnel with motorized zoom



SPEED UP YOUR SHOOT



electronic zoom

goodbye manual beam changes

KOSMOS is a compact color-tunable Fresnel producing unprecedented output with motorized ZOOM and total wireless control.



A borosilicate glass Fresnel lens guarantees a perfectly homogeneous beam with consistent color reproduction along the years. The shadow and color light is homogeneous throughout the beam range.

- Change on air the powerful light beam angle from 13° to 56°.
- No more hassle replacing fixed optics to have different beam angles.
- Beam control is instant at your fingertips, locally or remotely, wire or wirelessly.

true HMI/Tungsten evolution

The ultra-compact KOSMOS produces light output unseen before from a color tunable LED Fresnel in either white light or color modes. Seeing is indeed believing. The performance that delivers matches or exceeds that of traditional light fixtures in output, color rendition and shadow quality at any angle.



SMART FAN CONTROL

KOSMOS 400

Same as a 1.2Kw HMI/ 2Kw tungsten fresnel
Twice output of any 500W color LED fresnel

3D chamber cooling system

Compactness comes from an extremely compact and lightweight passive liquid cooling system designed by VELVET engineers.

This aerospace-grade system is controlled with three heat sensors and a variable speed silent fan protected by an air filter to keep the light engine and electronics running at peak performance. Made of copper instead of the traditional aluminum transfers the heat out of the LED light engine with a unique efficiency to warranty many years of consistent operation.

total control

Three Wireless Protocols

KOSMOS gives you immediate remote control over beam angle, color, effects or presets from your smartphone or tablet

- Built-in wireless control includes LumenRadio CRMX (available only on KOSMOS Location)
- Wi-Fi
- Bluetooth
- VELVET Goya free of charge App available for Android and iOS.

VELVET GOYA app



VELVET GOYA free App gives you instant control over any KOSMOS

You can immediately save or load any setting including the beam light angle, reset to 3200K or 5600K white light, create your own gels and presets, make complex light schemes and control unlimited number of KOSMOS and also VELVET EVO fixtures. Your creative possibilities are unlimited.

This quick and precise App is available free of charge for Android and iOS.

intuitive touchscreen

The full color touchscreen simplifies any light, zoom or effects setting while two rotary knobs provide precise manual adjustments.



full color

extend your creative possibilities

KOSMOS simplifies color selection and adjustment showing on the touchscreen the actual color you are creating. The beam angle can always be adjusted on any mode.



V5
ceramic
LIGHT ENGINE



color modes
with motorized zoom



from now on **KOSMOS**

Its powerful CPU and advanced electronics are even capable to learn new features or upcoming updates

KOSMOS unique features are designed to speed up your productions: remote beam angle control, Fresnel quality + multiple lampheads ecosystem and a breakthrough compactness and color output.

- Full output from AC&DC (26-48VDC) with double Vlock or Gold battery adapter
- Multiple lampheads ecosystem with quick mount
- Built-in AC power streamlining installation



technical specifications

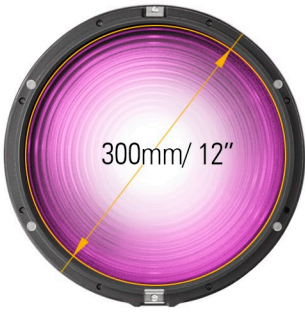

- COLOR TEMPERATURE** 2500 to 10000 Kelvin
- LED SYSTEM** 25mm color R+G+B+W+CW LED
- WORK MODES** CTT, HSI, CCTRGB, GELS & EFFECTS+ZOOM
- POWER** 400W power consumption (3.7 Amps at 110 VAC) with PFC
- WEIGHT** 9.3 kg/ 20.5 lbs fixture/ 9.8 kg/ 22.6 lbs fixture+yoke
- OPTICAL SYSTEM BEAM** KOSMOS 400/ 13° to 56° motorized ZOOM. KOSMOS 200/ 13° to 60° motorized ZOOM.
- LIGHT INTENSITY** smooth 0 to 100% dimming with four selectable dimming curves
- GREEN-MAGENTA** continuously adjustable (full Plusgreen to full Minusgreen)
- HIGH SPEED** over 12,000 fps

- CONTROL (LOCAL)** TFT full-color touchscreen display and 2 rotary control knobs
- CONTROL (WIRE)** full DMX-RDM with XLR-5 IN & OUT and RJ-45 Ethernet Art-Net (on Studio versions)
- CONTROL (WIRELESS)** Wi-Fi Art-Net and Bluetooth, Android and IOS free VELVET Goya App

- LED RATED LIFE (L70)** exceeds 50,000 hours
- AC INPUT VOLTAGE** AC INPUT 90-264V AC 50/60Hz PowerCon TRUE1 TOP IN & OUT connectors
- COOLING** passive liquid cooling system into sealed 3D chamber with silent fan
- PROTECTION** IP30, indoor or outdoor protected use
- CONSTRUCTION** fixture and yoke made of die-cast aluminum
- RIGGING OPTIONS** yoke+universal junior 1-1/8" / 28mm diameter+baby receiver 5/8" / 16mm. Pole operated yoke

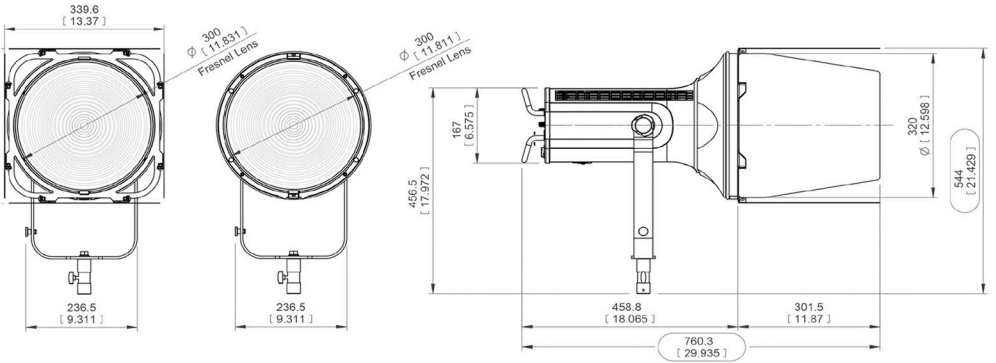

photometrics and graphics

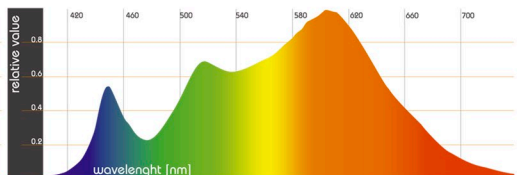
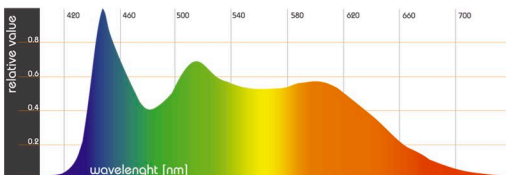
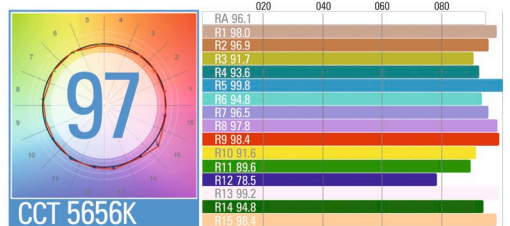
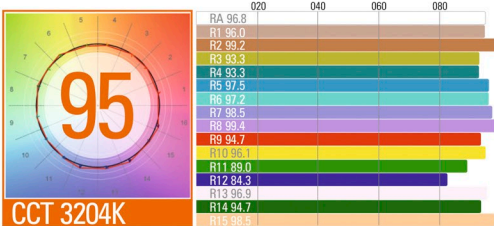
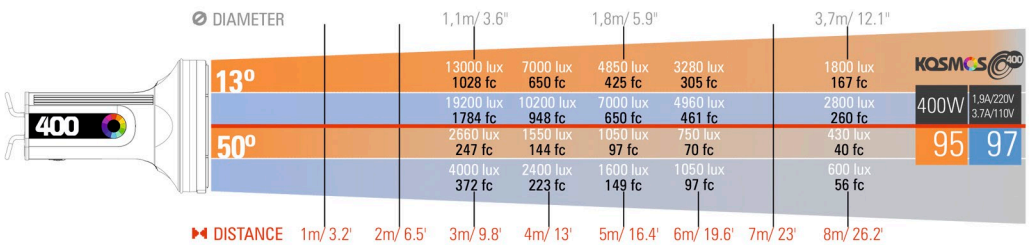



Intellectual Property. VELVET technology is protected under spanish patents and international patents pending.

Fresnel V5LED technology R+G+B+W+CW with motorized Zoom

SPEED UP YOUR SHOOT

13° to 56° beam angle
true Fresnel single shadow
remote beam angle adjustment
Compact & lightweight 9.3kg/20.5lbs (K400)

full output from AC/DC
unique color + ZOOM effects
built-in triple wireless control + free App
multiple lamphead ecosystem + quick mount

KOSMOS SITE



KOSMOS SUPPORT



USER MANUAL



European quality with 2 years warranty. 100% designed & made in Europe



velvetlight.tv

2022 Copyright VELVET. All rights reserved